

Panasonic
ideas for life

PhotoMOS Relays

RF Low C×R
SON type

The Smallest in the World[※]
CUTTING SPACE is CREATING SPACE

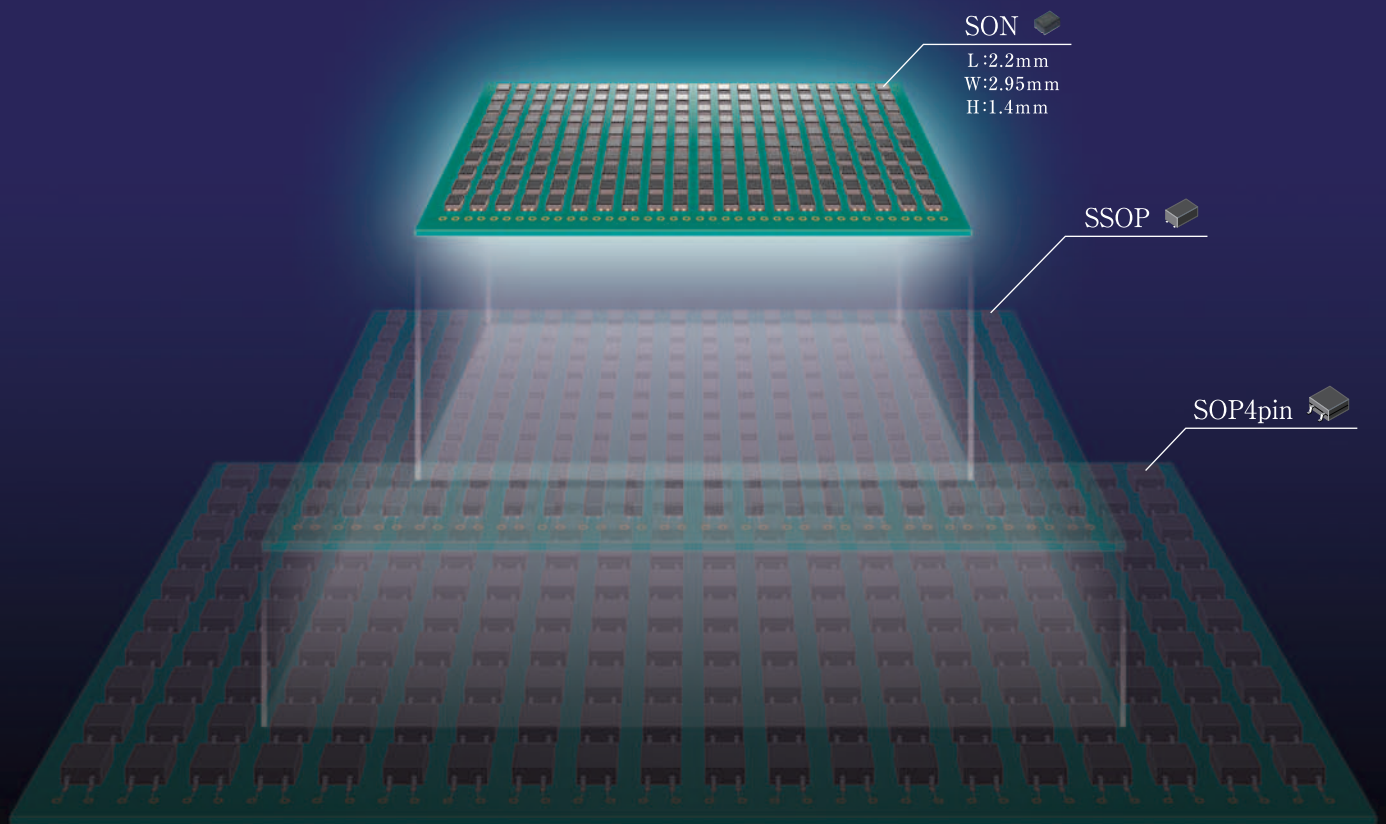

SON 
L:2.2mm
W:2.95mm
H:1.4mm

SSOP 

SOP4pin 

Can make much smaller equipment
with the smallest PhotoMOS relays in the world.

※ Intended segment includes all semiconductor relays using LED on input and MOSFET on output for switching element, isolated.



(L:2.2mm×W:2.95mm×H:1.4mm)

PhotoMOS Relays RF Low C×R SON type
ASCT1B353E '08-7

New

New



L 2.20mm .087inch
W 2.95mm .116inch
H 1.40mm .055inch

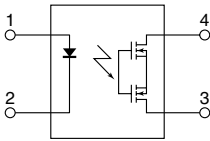

FEATURES

1. Super miniature SON* package contributes to space savings and high density mounting.

The SON type is a new PhotoMOS relay with approximately 43% the volume ratio of existing SSOP type. The super miniature leadless construction reduces the mounting area and enables high density mounting.

*Small Outline No-lead package

Reduced to approximately 43% volume ratio

Previous SSOP
(L: 2.65 × W: 4.45 × H: 1.80)
(L: .104 × W: .175 × H: .071)

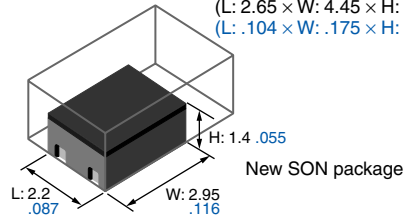

Area comparison (including leads)

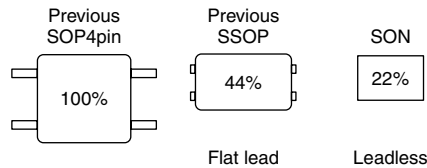

2. Full line-up featuring low on resistance (R type) and low capacitance (C type)

Line-up is comprised of three types: R type (with 40 V load voltage) and C type (with 25 V and 40 V load voltages).

3. Superior electrical performance

The achievement of both miniaturization and low CxR electrical performance make these relays ideal for high-accuracy switching control.

- C type with 25 V load voltage: C×R5
- C type and R type with 40 V load voltage: C×R10

TYPICAL APPLICATIONS

1. Measuring equipment

IC tester, Probe cards, board tester and other testing equipment.

2. Telecommunication or broadcasting equipment

3. Medical equipment

RoHS Directive compatibility information
<http://www.mew.co.jp/ac/e/environment/>

TYPES

Type		Output rating*1		Tape and reel packing style*2	
		Load voltage	Load current	Picked from the 1 and 4-pin side	Picked from the 2 and 3-pin side
AC/DC type	Low on resistance (R type)	40 V	250 mA	AQY221R2MY	AQY221R2MW
	Low capacitance (C type)	25 V	150 mA	AQY221N3MY	AQY221N3MW
		40 V	120 mA	AQY221N2MY	AQY221N2MW

Packing quantity: 3,500 pcs.

Notes: *1 Indicate the peak AC and DC values.

*2 Only tape and reel package is available.

For space reasons, only "1R2", "1N3" or "1N2" is marked on the product as the part number.

RATING

1. Absolute maximum ratings (Ambient temperature: 25°C 77°F)

Item		Symbol	AQY221R2M	AQY221N3M	AQY221N2M	Remarks
Input	LED forward current	I _F	50mA			
	LED reverse voltage	V _R	5V			
	Peak forward current	I _{FP}	1A			f=100 Hz, Duty factor=0.1%
	Power dissipation	P _{in}	75mW			
Output	Load voltage (peak AC)	V _L	40V	25V	40V	
	Continuous load current (peak AC)	I _L	0.25A	0.15A	0.12A	Peak AC, DC
	Peak load current	I _{peak}	0.75A	-		100ms (1shot), V _L =DC
	Power dissipation	P _{out}	250mW			
Total power dissipation		P _T	300mW			
I/O isolation voltage		V _{iso}	200V AC			
Operating temperature		T _{opr}	-40°C to +85°C -40°F to +185°F			Non-condensing at low temperatures
Storage temperature		T _{stg}	-40°C to +100°C -40°F to +212°F			

2. Electrical characteristics (Ambient temperature: 25°C 77°F)

Item			Symbol	R type	C type		Condition	
				AQY221R2M	AQY221N3M	AQY221N2M		
Input	LED operate current	Typical	I_{Fon}	0.8 mA	1.0 mA		R type: $I_L = 250$ mA C type: $I_L = 80$ mA	
		Maximum		3.0 mA				
	LED turn off current	Minimum	I_{Foff}	0.2 mA				
		Typical		0.7 mA	0.9 mA			
	LED dropout voltage	Typical	V_F	1.35 V (1.14 V at $I_F = 5$ mA)				$I_F = 50$ mA
		Maximum		1.5 V				
Output	On resistance	Typical	R_{on}	0.8Ω	5.5Ω	9.5Ω	R type: $I_F = 5$ mA, $I_L = 250$ mA C type: $I_F = 5$ mA, $I_L = 80$ mA Within 1 s on time	
		Maximum		1.25Ω	7.5Ω	12.5Ω		
	Output capacitance	Typical	C_{out}	14 pF	1.1 pF		$I_F = 0$ mA $V_B = 0$ V $f = 1$ MHz	
		Maximum		18 pF	1.5 pF			
	Off state leakage current	Typical	I_{Leak}	0.01 nA			$I_F = 0$ mA $V_L = Max.$	
		Maximum		10 nA				
Transfer characteristics	Turn on time*	Typical	T_{on}	0.2 ms	0.02 ms		R type: $I_F = 5$ mA, $V_L = 10$ V, $R_L = 40Ω$ C type: $I_F = 5$ mA, $V_L = 10$ V, $R_L = 125Ω$	
		Maximum		0.5 ms	0.2 ms			
	Turn off time*	Typical	T_{off}	0.04 ms	0.02 ms			
		Maximum		0.2 ms				
	I/O capacitance	Typical	C_{iso}	0.8 pF				$f = 1$ MHz $V_B = 0$ V
		Maximum		1.5 pF				

Notes: 1. Please refer to the schematic and wiring diagram for connection method.

2. Variation possible through combinations of output capacitance and On resistance. For more information, please contact our sales office in your area.

*Turn on/Turn off time

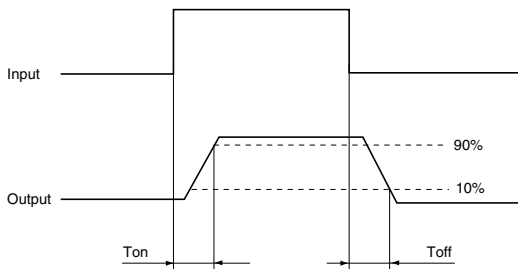

RECOMMENDED OPERATING CONDITIONS

Please obey the following conditions to ensure proper relay operation (turn on) and resetting (turn off).

Item	Symbol	Recommended value	Unit
Input LED current	I_F	5	mA

REFERENCE DATA

1. Load current vs. ambient temperature characteristics

Allowable ambient temperature: -40°C to +85°C
-40°F to +185°F

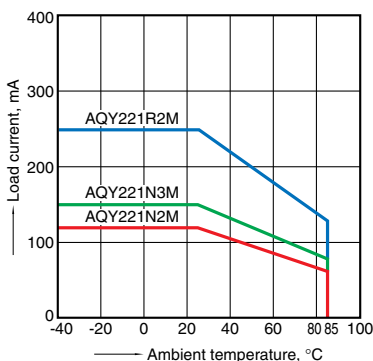

2. Load current vs. Load voltage characteristics
Ambient temperature: 25°C 77°F

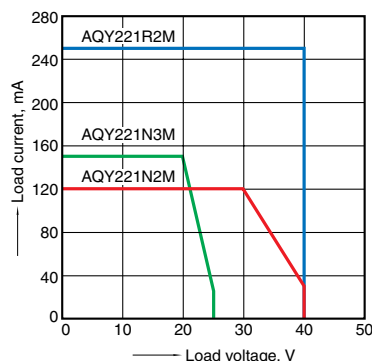

3. On resistance vs. ambient temperature characteristics

Measured portion: between terminals 3 and 4;
LED current: 5 mA; Load voltage: 10V (DC); Load current: 250mA (DC) R type, 80mA (DC) C type

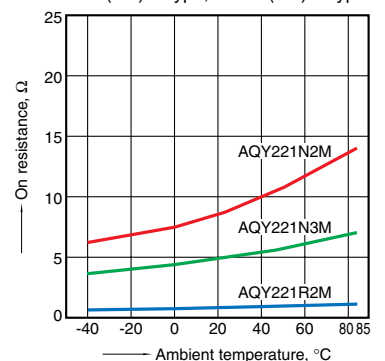

RF PhotoMOS (AQY221◯◯M)

4. Turn on time vs. ambient temperature characteristics

Measured portion: between terminals 3 and 4; LED current: 5 mA; Load voltage: 10V (DC); Continuous load current: 250mA (DC) R type, 80mA (DC) C type

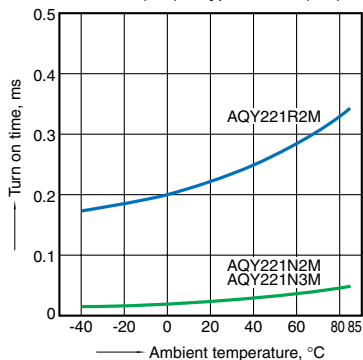

5. Turn off time vs. ambient temperature characteristics

Measured portion: between terminals 3 and 4; LED current: 5 mA; Load voltage: 10V (DC); Continuous load current: 250mA (DC) R type, 80mA (DC) C type

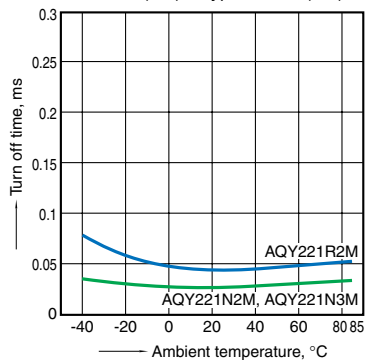

6. LED operate current vs. ambient temperature characteristics

Measured portion: between terminals 3 and 4; Load voltage: 10V (DC); Continuous load current: 250mA (DC) R type, 80mA (DC) C type

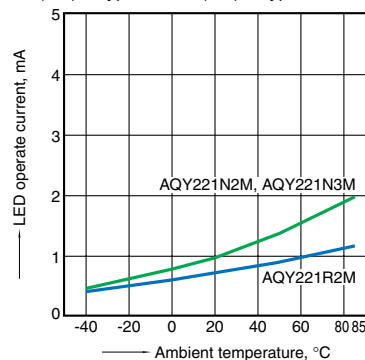

7. LED turn off current vs. ambient temperature characteristics

Measured portion: between terminals 3 and 4; Load voltage: 10V (DC); Continuous load current: 250mA (DC) R type, 80mA (DC) C type

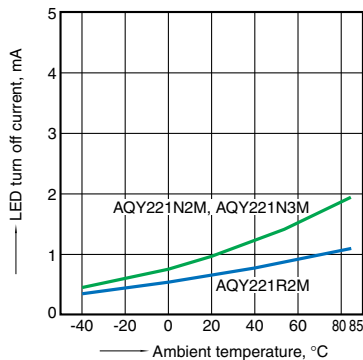

8. LED dropout voltage vs. ambient temperature characteristics

LED current: 5 to 50 mA

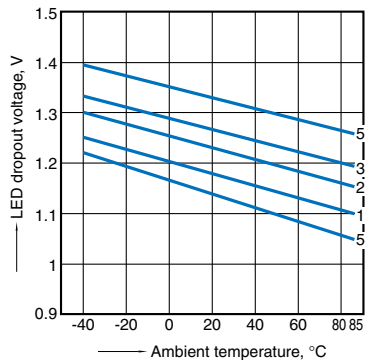

9. Current vs. voltage characteristics of output at MOS portion

Measured portion: between terminals 3 and 4
Ambient temperature: 25°C 77°F

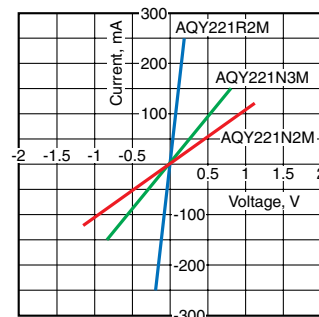

10. Off state leakage current vs. load voltage characteristics

Measured portion: between terminals 3 and 4
Ambient temperature: 25°C 77°F

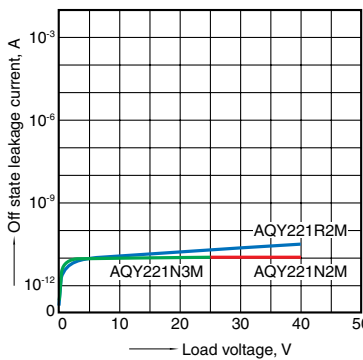

11. Turn on time vs. LED forward current characteristics

Measured portion: between terminals 3 and 4; Load voltage: 10V (DC); Continuous load current: 250mA (DC) R type, 80mA (DC) C type; Ambient temperature: 25°C 77°F

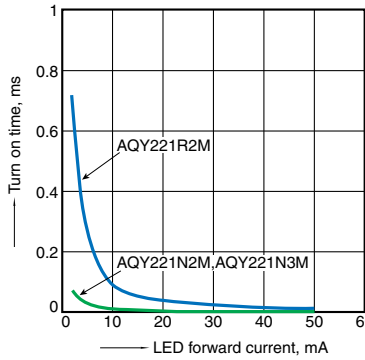

12. Turn off time vs. LED forward current characteristics

Measured portion: between terminals 3 and 4; Load voltage: 10V (DC); Continuous load current: 250mA (DC) R type, 80mA (DC) C type; Ambient temperature: 25°C 77°F

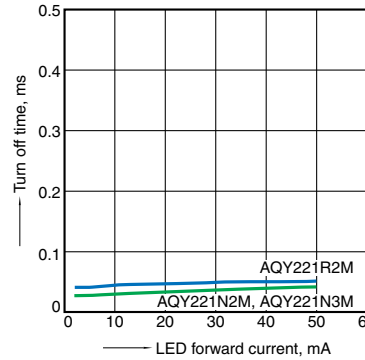

13. Output capacitance vs. applied voltage characteristics

Measured portion: between terminals 3 and 4; Frequency: 1 MHz, 30m Vrms; Ambient temperature: 25°C 77°F

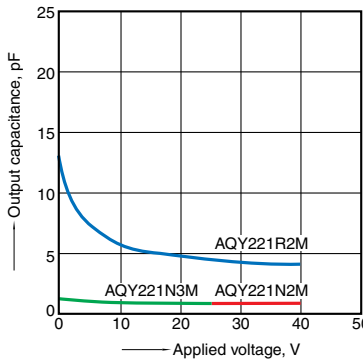

14. Isolation vs. frequency characteristics (50Ω impedance)

Measured portion: between terminals 3 and 4
Ambient temperature: 25°C 77°F

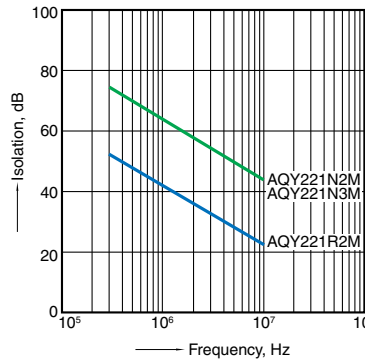

15. Insertion loss vs. frequency characteristics (50Ω impedance)

Measured portion: between terminals 3 and 4
Ambient temperature: 25°C 77°F

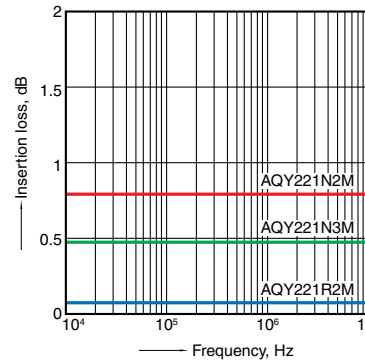

16.-(1) On resistance distribution

Sample: AQY221R2M; Measured portion: between terminals 3 and 4; Continuous load current: 250mA (DC) R type, 80mA (DC) C type, n: 50pcs.
Ambient temperature: 25°C 77°F

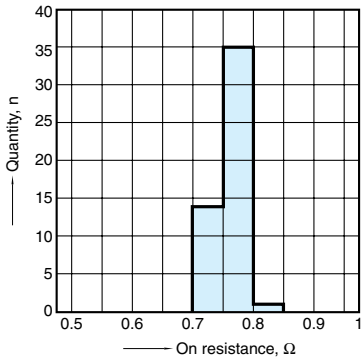

16.-(2) On resistance distribution

Sample: AQY221N3M; Measured portion: between terminals 3 and 4; Continuous load current: 250mA (DC) R type, 80mA (DC) C type, n: 50pcs.
Ambient temperature: 25°C 77°F

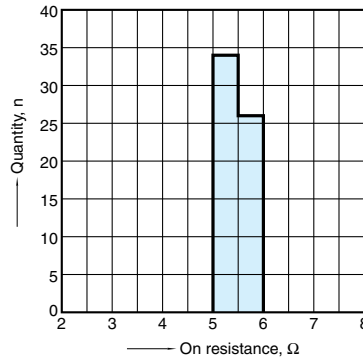

16.-(3) On resistance distribution

Sample: AQY221N2M; Measured portion: between terminals 3 and 4; Continuous load current: 250mA (DC) R type, 80mA (DC) C type, n: 50pcs.
Ambient temperature: 25°C 77°F

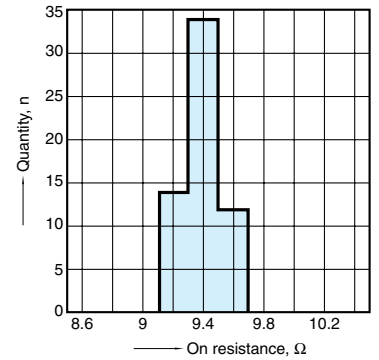

17.-(1) Turn on time distribution

Sample: AQY221R2M; Load voltage: 10V (DC)
Continuous load current: 250mA (DC) R type, 80mA (DC) C type, n: 50pcs.
Ambient temperature: 25°C 77°F

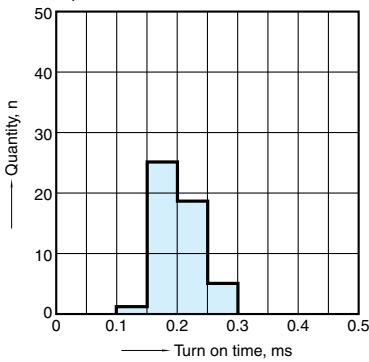

17.-(2) Turn on time distribution

Sample: AQY221N3M; Load voltage: 10V (DC)
Continuous load current: 250mA (DC) R type, 80mA (DC) C type, n: 50pcs.
Ambient temperature: 25°C 77°F

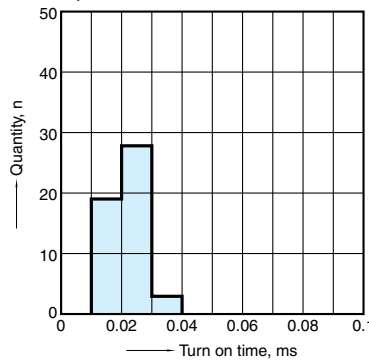

17.-(3) Turn on time distribution

Sample: AQY221N2M; Load voltage: 10V (DC)
Continuous load current: 250mA (DC) R type, 80mA (DC) C type, n: 50pcs.
Ambient temperature: 25°C 77°F

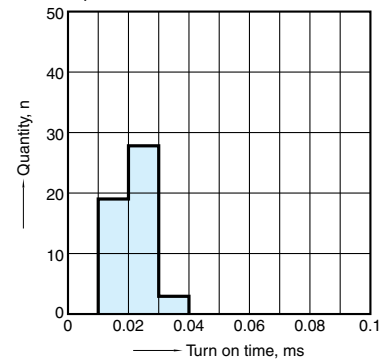

18.-(1) Turn off time distribution

Sample: AQY221R2M; Load voltage: 10V (DC)
Continuous load current: 250mA (DC) R type, 80mA (DC) C type, n: 50pcs.
Ambient temperature: 25°C 77°F

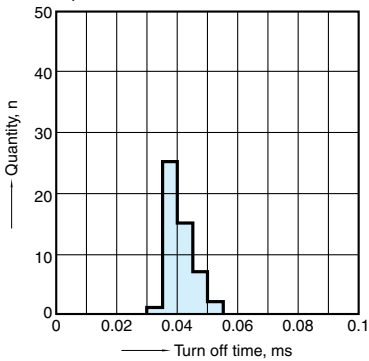

18.-(2) Turn off time distribution

Sample: AQY221N3M; Load voltage: 10V (DC)
Continuous load current: 250mA (DC) R type, 80mA (DC) C type, n: 50pcs.
Ambient temperature: 25°C 77°F

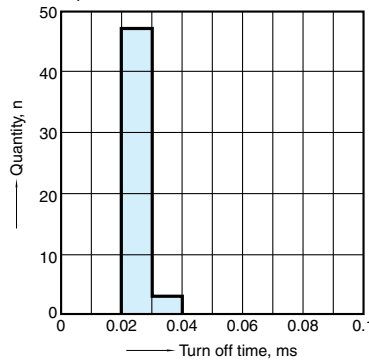

18.-(3) Turn off time distribution

Sample: AQY221N2M; Load voltage: 10V (DC)
Continuous load current: 250mA (DC) R type, 80mA (DC) C type, n: 50pcs.
Ambient temperature: 25°C 77°F

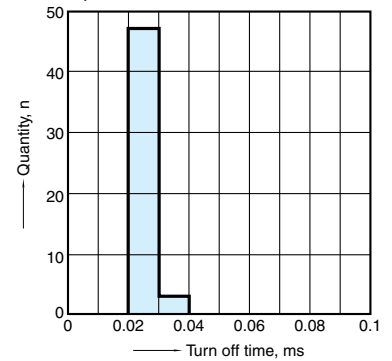

19.-(1) LED operate current distribution

Sample: AQY221R2M; Load voltage: 10V (DC)
Continuous load current: 250mA (DC) R type, 80mA (DC) C type, n: 50pcs.
Ambient temperature: 25°C 77°F

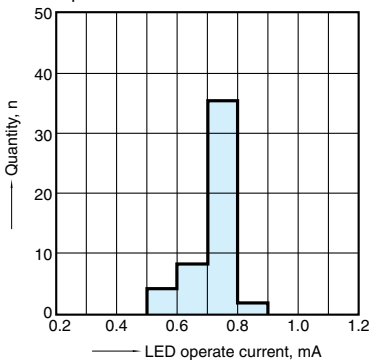

19.-(1) LED operate current distribution

Sample: AQY221N3M; Load voltage: 10V (DC)
Continuous load current: 250mA (DC) R type, 80mA (DC) C type, n: 50pcs.
Ambient temperature: 25°C 77°F

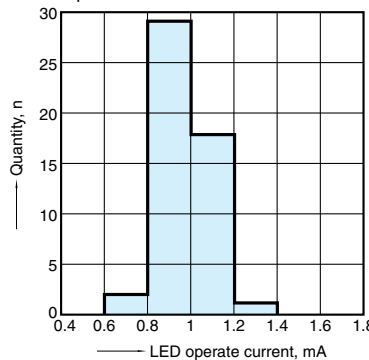

19.-(1) LED operate current distribution

Sample: AQY221N2M; Load voltage: 10V (DC)
Continuous load current: 250mA (DC) R type, 80mA (DC) C type, n: 50pcs.
Ambient temperature: 25°C 77°F

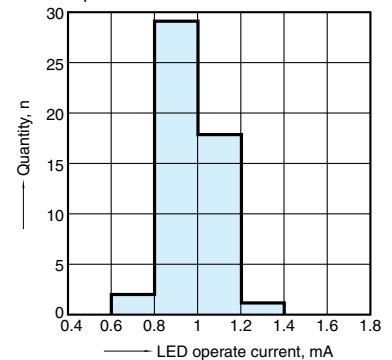

RF PhotoMOS (AQY221○○M)

DIMENSIONS (Unit: mm inch)



External dimensions

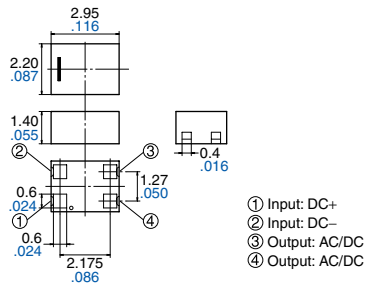

General Tolerance: $\pm 0.2 \pm .008$

Recommended mounting pad
(Top view)

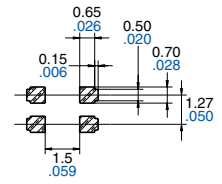

Tolerance: $\pm 0.1 \pm .004$

SCHEMATIC AND WIRING DIAGRAMS

E_F: Power source at input side; I_F: LED forward current; V_L: Load voltage; I_L: Load current

Schematic	Output configuration	Load	Con-nection	Wiring diagram
	1a	AC/DC	—	

PhotoMOS Relay Cautions for Use

SAFETY WARNINGS

• Do not use the product under conditions that exceed the range of its specifications. It may cause overheating, smoke, or fire.

• Do not touch the recharging unit while the power is on. There is a danger of electrical shock. Be sure to turn off the power when performing mounting, maintenance, or repair operations on the relay (including connecting parts such as the terminal board and socket).

• Check the connection diagrams in the catalog and be sure to connect the terminals correctly. Erroneous connections could lead to unexpected operating errors, overheating, or fire.

PhotoMOS RELAY CAUTIONS FOR USE

1. Please refer to “PhotoMOS Relays” catalog (latest version) for cautions for use and explanations of terminology.

2. Applying stress that exceeds the absolute maximum rating

If the voltage or current value for any of the terminals exceeds the absolute maximum rating, internal elements will deteriorate because of the excessive voltage or current. In extreme cases, wiring may melt, or silicon P/N junctions may be destroyed.

Therefore, the circuit should be designed in such a way that the load never exceed the absolute maximum ratings, even momentarily.

3. Deterioration and destruction caused by discharge of static electricity

This phenomenon is generally called static electricity destruction, and occurs when static electricity generated by various factors is discharged while the relay terminals are in contact, producing internal destruction of the element. To prevent problems from static electricity, the following precautions and measures should be taken when using your device.

- 1) Employees handling relays should wear anti-static clothing and should be grounded through protective resistance of 500 k Ω to 1 M Ω .
- 2) A conductive metal sheet should be placed over the work table. Measuring instruments and jigs should be grounded.
- 3) Devices and equipment used in assembly should also be grounded.
- 4) When packing printed circuit boards and equipment, avoid using high-polymer materials such as foam styrene, plastic, and other materials which carry an electrostatic charge.
- 5) When storing or transporting relays, the environment should not be conducive to generating static electricity (for instance, the humidity should be between 45 and 60%), and relays should be protected using conductive packing materials.

4. Short across terminals

Do not short circuit between terminals when relay is energized, since there is possibility of breaking of the internal IC.

5. Output spike voltages

1) If an inductive load generates spike voltages which exceed the absolute maximum rating, the spike voltage must be limited. Typical circuits are shown below.

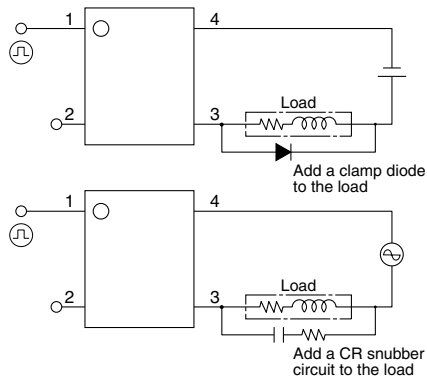

2) Even if spike voltages generated at the load are limited with a clamp diode if the circuit wires are long, spike voltages will occur by inductance. Keep wires as short as possible to minimize inductance.

6. Ripple in the input power supply

If ripple is present in the input power supply, observe the following:

- 1) For LED operate current at E_{min} , maintain the value mentioned in the table of “Recommended LED forward current (I_F).”
- 2) Keep the LED operate current at 50 mA or less at E_{max} .

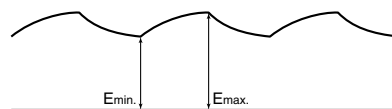

7. Soldering

• Example of recommended soldering conditions

IR (Infrared reflow) soldering method

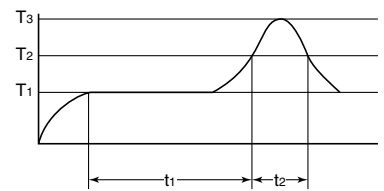

$T_1 = 150$ to 180°C 302 to 356°F
 $T_2 = 230^\circ\text{C}$ 446°F
 $T_3 = 245^\circ\text{C}$ 473°F or less
 $t_1 = 60$ to 120 s or less
 $t_2 = 30$ s or less

• When using lead-free solder, we recommend a type with an alloy composition of Sn 3.0 Ag 0.5 Cu. Please inquire about soldering conditions and other details.

• The temperature profile indicates the temperature of the soldered terminal on the surface of the PC board. The ambient temperature may increase excessively. Check the temperature under mounting conditions.

8. Notes for mounting

- 1) If many different packages are combined on a single substrate, then lead temperature rise is highly dependent on package size. For this reason, please make sure that the temperature of the terminal solder area of the PhotoMOS relay falls within the temperature conditions of item 7 before mounting.
- 2) If the mounting conditions exceed the recommended solder conditions in item 7, resin strength will fall and the nonconformity of the heat expansion coefficient of each constituent material will increase markedly, possibly causing cracks in the package, severed bonding wires, and the like. For this reason, please inquire with us about whether this use is possible.
- 3) We recommend cleaning with an organic solvent. If you cannot avoid using ultrasonic cleansing, and check beforehand for defects.

RF PhotoMOS (AQY221○○M)

9. The following shows the packaging format

Tape and reel (Unit: mm inch)

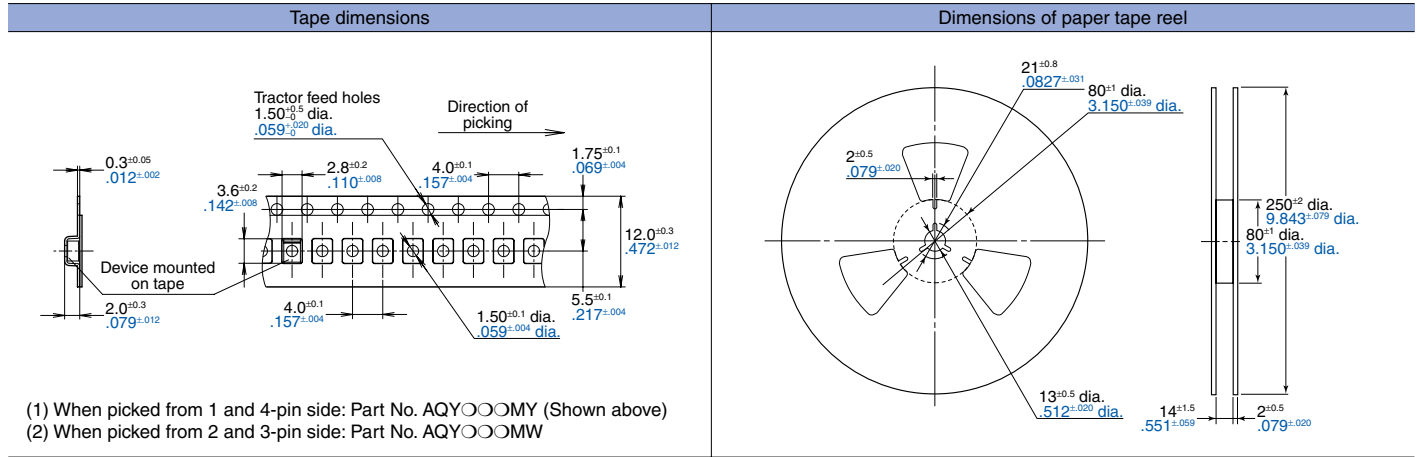

10. Transportation and storage

1) Extreme vibration during transport will damage the relay. Handle the outer and inner boxes with care.

2) PhotoMOS relays implemented in SON type are sensitive to moisture and come in sealed moisture-proof packages. Observe the following cautions on storage.

- After the moisture-proof package is unsealed, take the devices out of storage as soon as possible (within 1 month, less than 45°C 113°F/70% R.H.).

- If the devices are to be left in storage for a considerable period after the moisture-proof package has been unsealed, it is recommended to keep them in another moisture-proof bag containing silica gel (within 3 months at the most).

3) Storage under extreme conditions will cause soldering degradation, external appearance defects, and deterioration of the characteristics. The following storage conditions are recommended:

- Temperature: 0 to 45°C 32 to 113°F

- Humidity: Less than 70% R.H.

- Atmosphere: No harmful gasses such as sulfurous acid gas, minimal dust.